

## **KAN-therm** System

### Manifolds series 73A and 77A

#### Instruction manual

Manifolds 73A and 77A description and principles of operation . . . . .	18
Manifolds series 73A and 77A valves adjustment. . . . .	19
Manifolds series 73A and 77A installation, start-up and operation . . . . .	23



2011

© Copyright **KAN** Sp z o.o. All rights reserved.  
Copyrights include texts, pictures and their lay-out in **KAN** Sp z o.o. publications.

**KAN-therm** System - series 73A and 77A manifolds instruction manual

**Fig.1. Manifold series 73A**

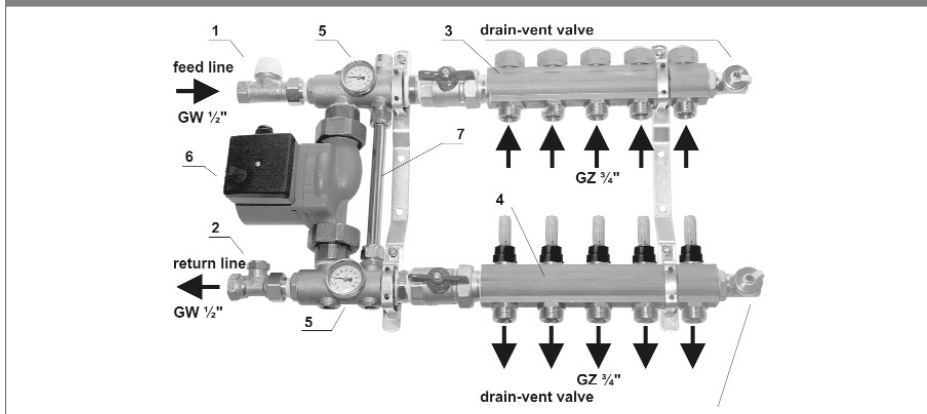

1. thermostatic valve TV;
2. control valve CV;
3. upper beam with actuator valves;
4. lower beam with control valves;
5. dial thermometers;
6. glandless pump RS 25/6;
7. by-pass with control valve.

**Fig.2. Manifold series 77A**

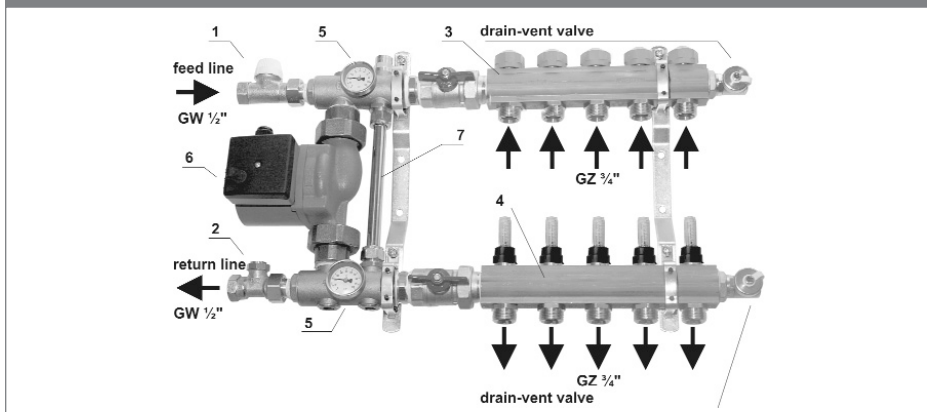

1. thermostatic valve TV;
2. control valve CV;
3. upper beam with actuator valves;
4. lower beam with flowmeters;
5. dial thermometers;
6. glandless pump RS 25/6;
7. by-pass with control valve.

## KAN-therm System - series 73A and 77A manifolds instruction manual

### Manifolds 73A and 77A - Description and principles of operation

Manifolds series 73A and 77A provide precise and optimum floor heating system control. A built-in system of pump mix provides lower heating medium parameters to a chosen temperature for floor heating feed (e.g. from 80°C to 50°C). Floor heating loops are connected to the manifold by means of screw joints for PE-RT, PE-Xc pipes or by means of screw joints and connecting pipes for PE-RT/Al/PE-HD pipes. Connections of that type are self-sealing (do not apply additional seals in form of tow or teflon tape).

#### Manifolds series 73A and 77A description

Manifolds are consisting of (73A - Fig.1; 77A - Fig.2):

1. Thermostatic valve TV with female thread G $\frac{1}{2}$ " on feeding line (system input from installation) on which a head with a push-fit type sensor can be screwed on in order to manually control in-flow temperature of floor heating (it also protects against temperature rise above the value set on the head). Fix feeding head valve sensor on manifold lower beam using supplied mounting clamping ring. Optionally, on valve may be fixed an electric actuator (using adapter M30×1.5 mm - gray) connected with room thermostat (temperature value will be adjusted by thermostat knob - recommended in rooms with a few circuits connected to one manifold where it is unnecessary to control each circuit separately). Note that heads with sensors and electric actuators are not included in manifolds set;
2. Control valve CV with female thread G $\frac{1}{2}$ " on return line (system output to installation) which, when adjusted correctly, allows to obtain required degree of water mix and feeding temperature of floor heating;
3. Upper beam with built-in cut-off valves connected with electric actuators (fix actuators on valves using adapter M28×1.5 mm - red) and outputs G $\frac{3}{4}$ " (Eurokonus) for connecting pipes, and with drain-vent valve;
4. series 73A (Fig.1) - lower beam with built-in control valves (compensating flow resistance in particular coil pipes) and outputs G $\frac{3}{4}$ " (Eurokonus) for connecting pipes, and with drain-vent valve;  
series 77A (Fig.2) - lower beam with built-in flowmeters (compensating flow resistance in particular coil pipes and indicating real flow of heating medium in a coil), outputs G $\frac{3}{4}$ " (Eurokonus) for connecting pipes, and with drain-vent valve;
5. Two dial thermometers for floor heating temperature control (feed line - red, return one - blue);
6. Glandless three speeds pump RS 25/6 with cut-off valves;
2. By-pass line with control valve protecting the pump in case all cut-off valves in feed line close (manifold upper beam).

#### Manifolds series 73A and 77A operation

1. Pump is fed with hot water from the heating system through thermostatic valve TV and from floor heating coils returning line (upper beam), water is mixed and having reduced temperature flows-in manifold lower beam (feeding floor heating coil pipes).
2. Through control valve CV water returns to the system.
3. Required degree of water mix is obtained by setting control valve CV.
4. When actuators are fixed on all coil circuits, open by-pass valve by 1/4 turn, it ensures additional flow of 0.5 - 1 l/min (depending on pump speed level), protecting the pump against pumping water if the heating system is closed (i.e. all coil circuits are cut-off).

Make sure that the unit is correctly connected to the remaining part of the heating system. Fix the unit between feed and return lines of heat source circuit (installation with radiator); install thermostatic valve TV in feed line and control valve CV in return line.

## KAN-therm System - series 73A and 77A manifolds instruction manual

### Manifolds series 73A and 77A - Valves adjustment

#### By-pass valve adjustment

1. Unscrew protection on control valve using Allen key 6 mm - Fig.3.
2. Screw in valve head home using Allen key 5 mm, and then unscrew for  $\frac{1}{4}$  turn (Fig.4).
3. Screw in protection using Allen key 6 mm.

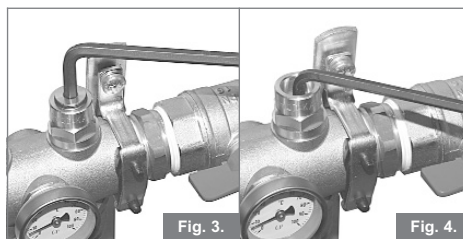

#### Control valve ZR adjustment

1. Unscrew cap using flat wrench 24 mm.
2. Screw in valve insert using Allen key 4 mm, until it has fully closed (Fig.5).
3. Unscrew valve insert for a given number of turns according to the design.
4. Screw on the cap.

Return valve characteristics are presented in Fig.11.  
To operate drain-vent valves use screw caps included in valve sets - Fig.6.

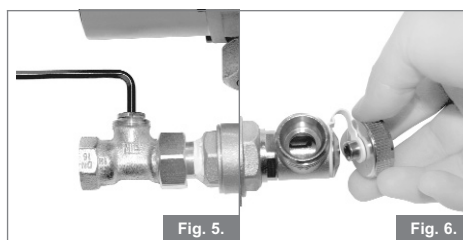

#### Manifold series 73A lower beam valves adjustment

1. Unscrew protection using Allen key 6 mm - Fig.7.
2. Adjust valve head using Allen key 5 mm by screwing it home (torque 6 Nm) and then making required number of turns to open according to the design - Fig.8.
3. After having made the adjustment screw in protection using Allen key 6 mm.

Valves characteristic is presented in Fig.12.

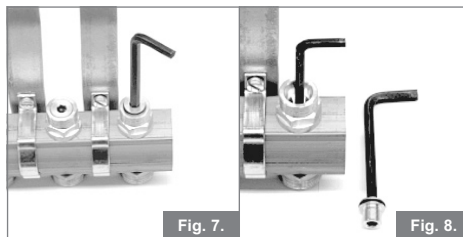

#### Manifold series 77A lower beam valves adjustment

1. Take off protection (fixed by "snap fastener") - Fig.9.
2. By turning the flowmeter adjust to the required flow on the scale (according to the design) - Fig.10.
3. After adjusting the flow, put on protection against accidental re-adjustment.

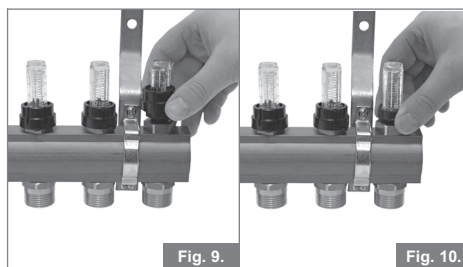

**KAN-therm** System - series 73A and 77A manifolds instruction manual

Manifold series 73A and 77A - Valves adjustment

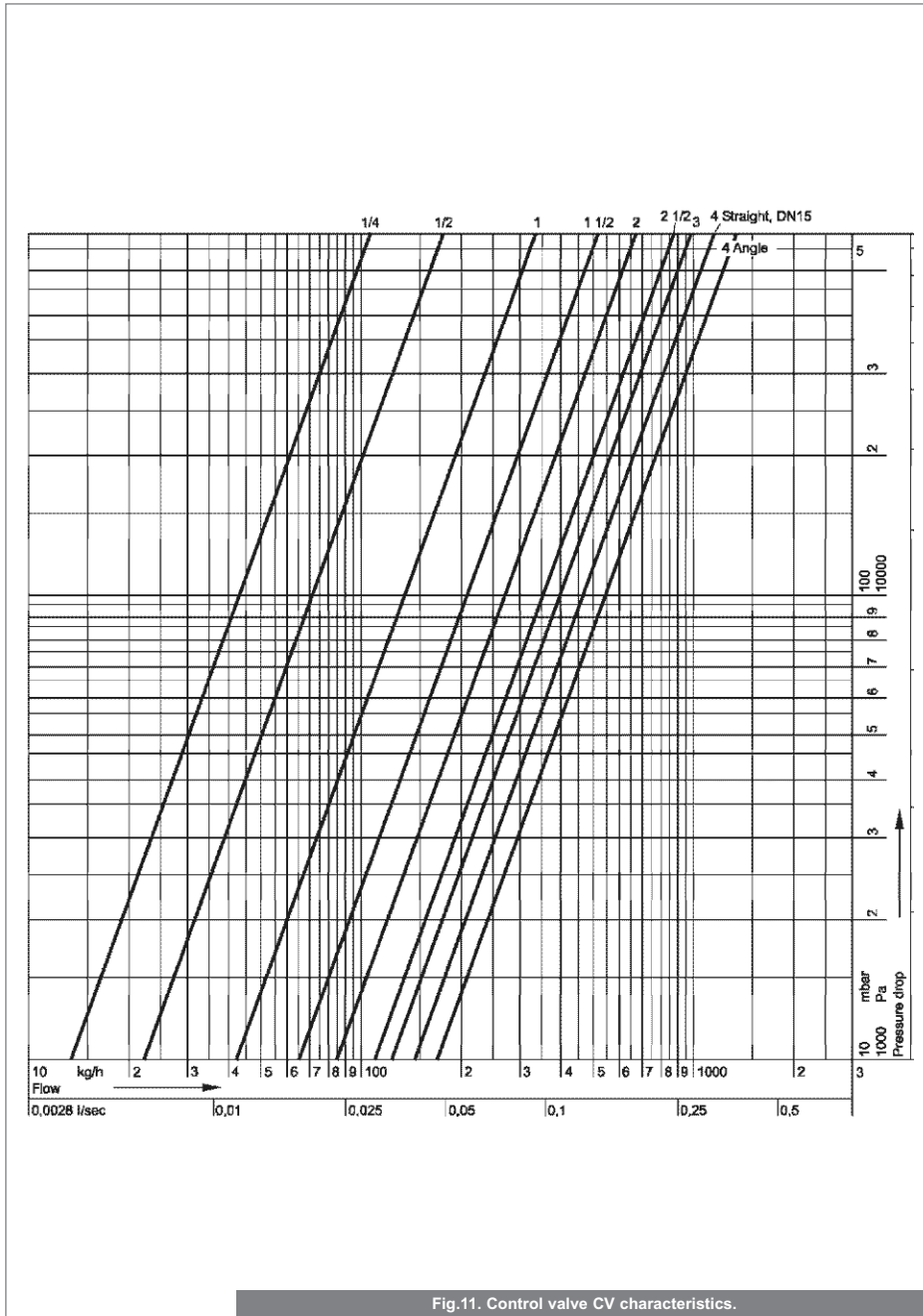
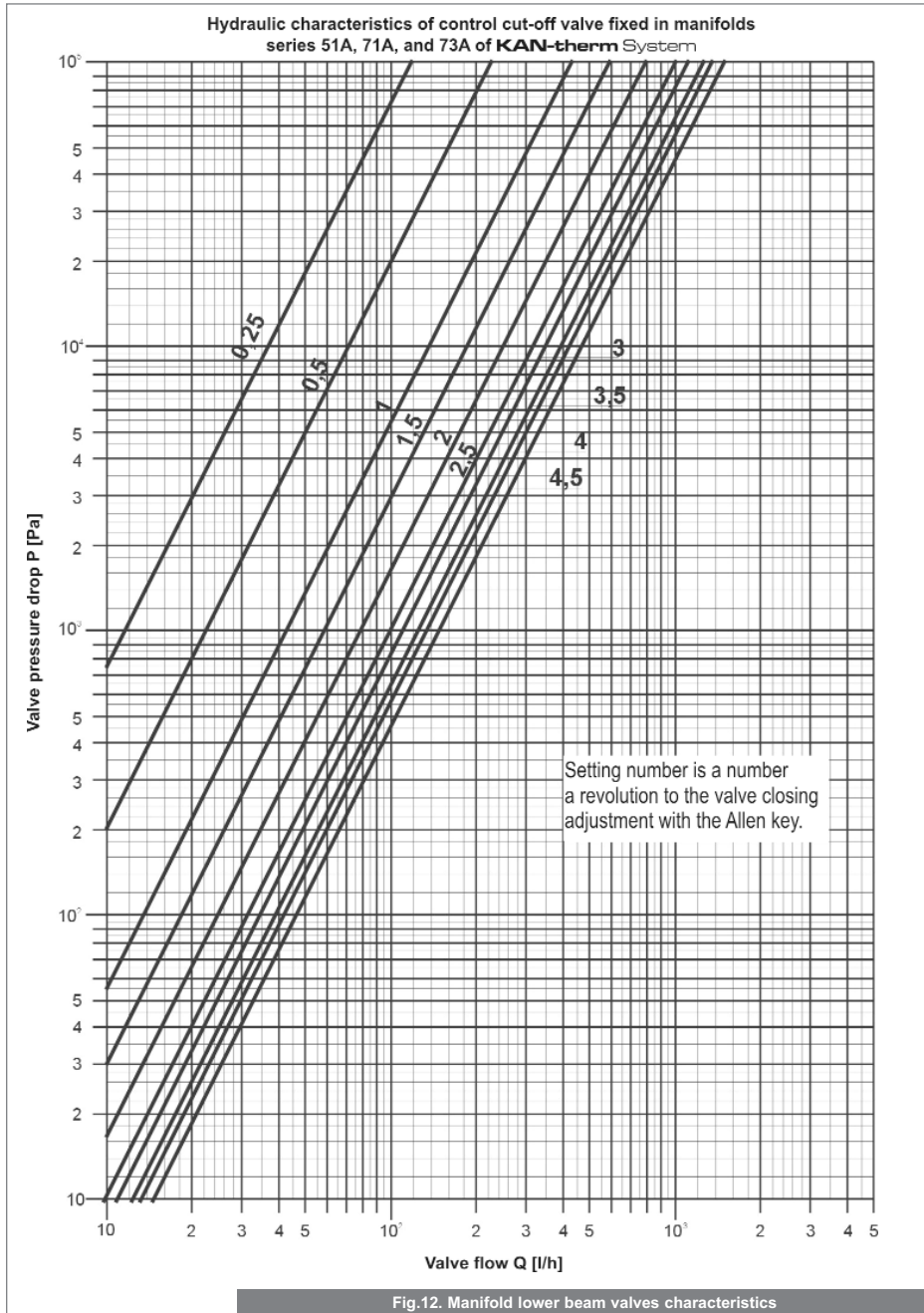

Fig.11. Control valve CV characteristics.

**KAN-therm** System - series 73A and 77A manifolds instruction manual

Manifold series 73A and 77A - Valves adjustment



## KAN-therm System - series 73A and 77A manifolds instruction manual

### Manifolds series 73A and 77A - Installation, start-up and operation

#### Connecting and pump adjustment

The pump does not require any maintenance during operation. Required flow characteristics are obtained by changing speed of motor by three-position switch located on electric box. Changes can be done while the pump is in operation. The pump should operate with capacity providing correct operation of heating system. Unjustified increase in rotation speed can cause the pump to wear out prematurely. Fill the whole system with water before starting the pump and vent the pump. **Do not allow the pump to operate "dry"**. In order to vent and check the pump, switch the pump to maximum speed (3), unscrew plug that is located on motor back panel and turn on the pump. Fig.13 presents the pump connection diagram to the electrical system. Pump characteristics are presented in Fig.14.

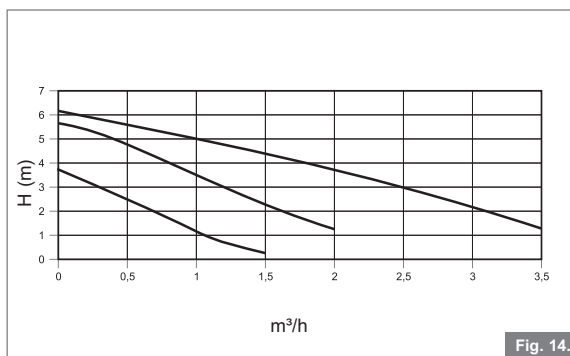
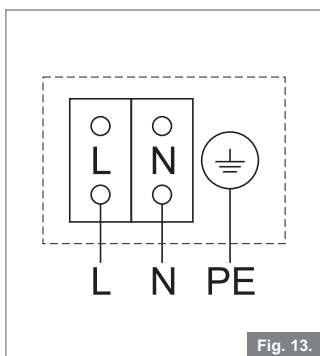

#### Actuators installation and start-up on valves in manifold upper beam

1. Unscrew manual adjustment cap (Fig.15).
2. Put room data label on the valve (the label is included in the actuator set).
3. Screw on actuator adapter M28×1.5 - red (Fig.16).
4. Fix actuator on adapter and turn at any required angle (Fig.17).
5. Calibrate actuator:
  - a) switch on power for approx. 6 min. (actuator and manifold circuit will open to the maximum);
  - b) switch of power and wait for approx. 6 min. (actuator and manifold circuit will close completely);
  - c) actuator is calibrated and ready for operation.

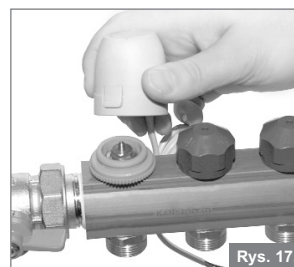
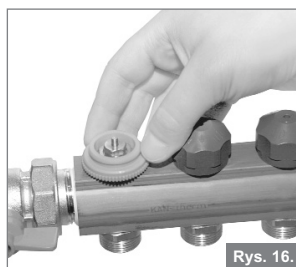
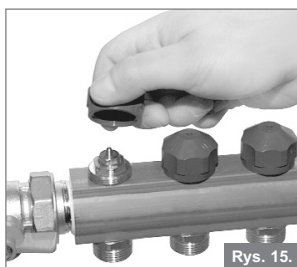

## KAN-therm System - series 73A and 77A manifolds instruction manual

### Manifolds series 73A and 77A Installation, start-up and operation

Electric actuators are available in two versions: 24V (K-600701) and 230V (K-600700). Actuator operates in NC mode (normally closed). To facilitate the start-up of the whole system, actuators have "first open" mode which makes them open before switching on the power for the first time. In order to ensure correct operation of manifold system, connect actuator to the power supply (230V or 24V) according to appropriate diagram (see connecting electric actuator to room thermostat diagram - Fig.18 and 19). More details see Actuator instruction manual.

### Connecting thermostats and actuators

1. It is possible to connect up to 10 actuators to one thermostat.
2. Electric actuator operates with:
  - a) room bimetallic thermostats 230V (0.6106) - connection diagram see Fig.18;
  - b) electronic thermostats with diode 230V (K-800100) - connection see diagram Fig. 19;
  - c) electronic thermostats with diode 24V (K-800101) - connection see diagram Fig.19.

More details see Thermostat instruction manual.

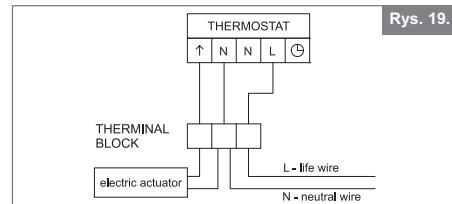
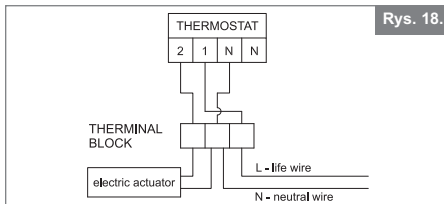

**Notice:** All works connected with electrical system should be performed by qualified and authorized personnel.

### System start-up

1. After making all hydraulic connections of the unit and electric connections of the pump, fill the installation with water.
  2. Open thermostatic valve TV, open 100% upper and lower beam valves, open pump ball valves, close control valve ZR.
  3. If actuators are installed for all coil circuits, adjust by-pass valve (open - ¼ turn); factory settings is closed.
  4. Vent and start the pump, vent the floor heating system (in the situation water circulates through pump and coils of floor heating or through by-pass).
  5. In heat source set and obtain design water temperature (e.g. 80°C) for radiators and flow through radiators. Then, open control valve TV making required number of turns, set the valve and obtain required temperature of floor heating feed. Set valve CV in two steps:
    - I. preliminary setting of feeding temperature at start-up of floor heating installation, equal to the design temperature - 10°C (max. 40°C),
    - II. final setting of feed temperature (on the next day), after heating up floor pavement and setting valves on lower beam (max. 50°C).
- Valves on manifold lower beam are set in order to obtain required flows in coils (valves adjustment - see p. 4). After adjusting valves on the lower beam and making final adjustment of valve CV, on thermostatic valve TV put a sensor valve head or electric actuator (thermostat control version).